

DATA SHEET

SFP-GE-CWXX-ZX-C-GEN

1.25 Gb/s SFP (Small Form Pluggable) CWDM (1270nm - 1610nm) Transceiver

Overview

SFP-GE-CWXX-ZX-C-GEN SFP optical transceivers are designed for Gigabit Ethernet and Fibre Channel network equipment, they are available in 18 different CWDM wavelengths, from 1270nm to 1610nm. The product implements digital diagnostics via a 2-wire serial bus, compliant with the INF-8074i Small Form Factor Pluggable Multi-Source Agreement (MSA) and SFF-8472 standard.

Product Features

- Up to 1.25 Gb/s bi-directional data links
- Compliant with IEEE 802.3 Gigabit Ethernet standard
- Compliant with Fiber Channel 100-SM-LL-V standard
- Industry standard small form pluggable (SFP) package
- Compliant with SFP MSA
- Hot-pluggable SFP footprint
- Uncooled DFB laser transmitter in 18 CWDM wavelengths
- Receiver with PIN
- Duplex LC connector
- Built-in digital diagnostic functions
- Up to 80km on 9/125um SMF
- Single power supply 3.3V
- RoHS Compliant
- Class 1 laser product complies with EN 60825-1
- Operating temperature range: Class C 0°C to 70°C

Applications

- 1.25Gb/s Gigabit Ethernet
- 1.063Gb/s Fiber Channel

Ordering Information

Part Number	Product ID	Description	Color on Clasp
SFP-GE-CW27-ZX-C-GEN	M317802W1270	GE/FC SFP CWDM 1270nm The link budget is 26dB,Commercial temperature	Light purple
SFP-GE-CW29-ZX-C-GEN	M317802W1290	GE/FC SFP CWDM 1290nm The link budget is 26dB,Commercial temperature	sky blue
SFP-GE-CW31-ZX-C-GEN	M317802W1310	GE/FC SFP CWDM 1310nm The link budget is 26dB,Commercial temperature	Yellow green
SFP-GE-CW33-ZX-C-GEN	M317802W1330	GE/FC SFP CWDM 1330nm The link budget is 26dB,Commercial temperature	Yellow ocher
SFP-GE-CW35-ZX-C-GEN	M317802W1350	GE/FC SFP CWDM 1350nm The link budget is 26dB,Commercial temperature	Pink
SFP-GE-CW37-ZX-C-GEN	M317802W1370	GE/FC SFP CWDM 1370nm The link budget is 26dB,Commercial temperature	Beige
SFP-GE-CW39-ZX-C-GEN	M317802W1390	GE/FC SFP CWDM 1390nm The link budget is 26dB,Commercial temperature	White
SFP-GE-CW41-ZX-C-GEN	M317802W1410	GE/FC SFP CWDM 1410nm The link budget is 26dB,Commercial temperature	Silver
SFP-GE-CW43-ZX-C-GEN	M317802W1430	GE/FC SFP CWDM 1430nm The link budget is 26dB,Commercial temperature	Black
SFP-GE-CW45-ZX-C-GEN	M317802W1450	GE/FC SFP CWDM 1450nm The link budget is 26dB,Commercial temperature	Yellow orange
SFP-GE-CW47-ZX-C-GEN	M317802W1470	GE/FC SFP CWDM 1470nm The link budget is 26dB,Commercial temperature	Gray
SFP-GE-CW49-ZX-C-GEN	M317802W1490	GE/FC SFP CWDM 1490nm The link budget is 26dB,Commercial temperature	Purple
SFP-GE-CW51-ZX-C-GEN	M317802W1510	GE/FC SFP CWDM 1510nm The link budget is 26dB,Commercial temperature	Blue
SFP-GE-CW53-ZX-C-GEN	M317802W1530	GE/FC SFP CWDM 1530nm The link budget is 26dB,Commercial temperature	Green
SFP-GE-CW55-ZX-C-GEN	M317802W1550	GE/FC SFP CWDM 1550nm The link budget is 26dB,Commercial temperature	Yellow
SFP-GE-CW57-ZX-C-GEN	M317802W1570	GE/FC SFP CWDM 1570nm The link budget is 26dB,Commercial temperature	Orange
SFP-GE-CW59-ZX-C-GEN	M317802W1590	GE/FC SFP CWDM 1590nm The link budget is 26dB,Commercial temperature	Red
SFP-GE-CW61-ZX-C-GEN	M317802W1610	GE/FC SFP CWDM 1610nm The link budget is 26dB,Commercial temperature	Brown
<p>For More Information: SONGXIN TAIPEI TECH SOLUTIONS CO., LTD. Web: www.songxin.com.tw Email: oversea@songxin.com.tw</p>			

General Specifications

Parameter	Symbol	Min	Typ	Max	Unit	Remarks
Data Rate	DR	0.622		1.25	Gb/s	
Bit Error Rate	BER			10^{-12}		
Operating Temperature	T _C	0		70	°C	1
Storage Temperature	T _{STO}	-40		85	°C	2
Supply Current	I _{CC}		200	300	mA	3
Input Voltage	V _{CC}	3.14	3.3	3.46	V	
Maximum Voltage	V _{MAX}	-0.5		4	V	3
Maximum Power Consumption	P _C			1	W	4

Notes:

1. Case temperature
2. Ambient temperature
3. For electrical power interface
4. The max power consumption refers to the max power consumption of optical module under nominal maximum operating temperature and in a flow test environment

Transmission distance

Data Rate	Optical Fiber type	Distance range (km)	Remark
1.25Gb/s	9/125um Singel mode fiber	80	

Optical – Characteristics – Transmitter

$V_{CC}=3.14V$ to $3.46V$, $T_C=0^{\circ}C$ to $70^{\circ}C$

Parameter	Symbol	Min	Typ	Max	Unit	Remarks
Output Optical Power	P_{TX}	0		5	dBm	1
Optical Center Wavelength - 1270nm	λ_c	1265	1271	1277	nm	
Optical Center Wavelength - 1290nm		1285	1291	1297	nm	
Optical Center Wavelength - 1310nm		1305	1311	1317	nm	
Optical Center Wavelength - 1330nm		1325	1331	1337	nm	
Optical Center Wavelength - 1350nm		1345	1351	1357	nm	
Optical Center Wavelength - 1370nm		1365	1371	1377	nm	
Optical Center Wavelength - 1390nm		1385	1391	1397	nm	
Optical Center Wavelength - 1410nm		1405	1411	1417	nm	
Optical Center Wavelength - 1430nm		1425	1431	1437	nm	
Optical Center Wavelength - 1450nm		1445	1451	1457	nm	
Optical Center Wavelength - 1470nm		1465	1471	1477	nm	
Optical Center Wavelength - 1490nm		1485	1491	1497	nm	
Optical Center Wavelength - 1510nm		1505	1511	1517	nm	
Optical Center Wavelength - 1530nm		1525	1531	1537	nm	
Optical Center Wavelength - 1550nm		1545	1551	1557	nm	
Optical Center Wavelength - 1570nm		1565	1571	1577	nm	
Optical Center Wavelength - 1590nm		1585	1591	1597	nm	
Optical Center Wavelength - 1610nm		1605	1611	1617	nm	
Wavelength Temperature Dependence			0.08	0.125	nm/ $^{\circ}C$	
Extinction Ratio	ER	9			dB	
Side Mode Suppression Ratio	SMSR	30			dB	
Spectral Width (-20dB)	$\Delta\lambda$			1	nm	
Optical Rise/Fall Time (20%-80%)	t_r / t_f			180	ps	
Relative Intensity Noise	RIN			-120	dB/Hz	
Transmitter Jitter (peak to peak)	TJ			100	ps	
Output Eye	Compliant with IEEE 802.3					

Notes:

1. Class 1 Product

Typical Eye Diagram

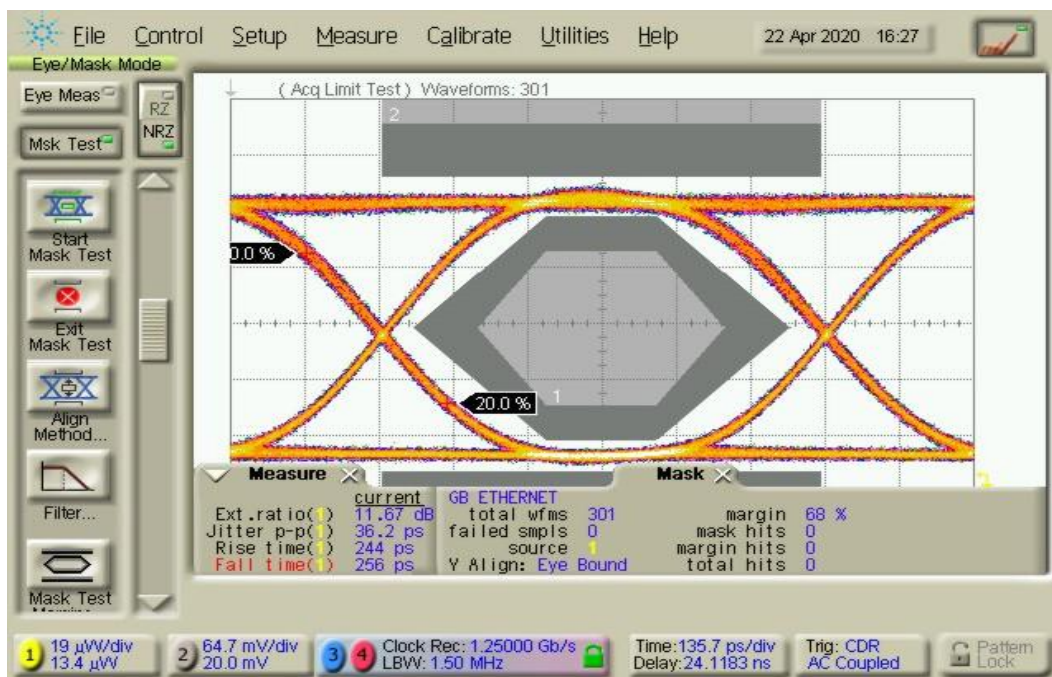

Data pattern : 1.25Gb/s · PRBS 27-1

Optical – Characteristics – Receiver

$V_{CC}=3.14V$ to $3.46V$, $T_C=0^{\circ}C$ to $70^{\circ}C$

Parameter	Symbol	Min	Typ	Max	Unit	Remarks
Receiver Overload	P_{OL}	0			dBm	
Optical Center Wavelength	λ_c	1260		1620	nm	
Receiver Sensitivity @ 1.25Gb/s	$R_{X,SEN}$			-26	dBm	1
LOS Assert	LOS_A	-35			dBm	
LOS De-Assert	LOS_D			-26	dBm	
LOS Hysteresis	LOS_H		0.5		dB	

Notes:

1. Measured with a 27-1 test pattern, @1.25Gb/s, BER < 10^{-12}

RX-LOS implementation method	Remarks
OMA(optical modulation amplitude)	

Electrical – Characteristics – Transmitter

$V_{CC}=3.14V$ to $3.46V$, $T_C=0^{\circ}C$ to $70^{\circ}C$

Parameter	Symbol	Min	Typ	Max	Unit	Remarks
Input differential impedance	R_{IN}		100		Ω	1
Single ended data input swing	V_{IN_PP}	250		1200	mV	
Transmit disable voltage	V_D	$V_{CC}-1.3$		V_{CC}	V	
Transmit enable voltage	V_{EN}	V_{EE}		$V_{EE}+0.8$	V	
Transmit disable assert time				10	μs	

Electrical – Characteristics – Receiver

$V_{CC}=3.14V$ to $3.46V$, $T_C=0^{\circ}C$ to $70^{\circ}C$

Parameter	Symbol	Min	Typ	Max	Unit	Remarks
Single ended data output swing	V_{OUT_PP}	300	400	800	mV	
Data output rise/fall time (20%-80%)	t_r/t_f		100	175	ps	
LOS Assert	V_{LOS_A}	$V_{CC}-0.5$		V_{CC_HOST}	V	
LOS De-Assert	V_{LOS_D}	V_{EE}		$V_{EE}+0.5$	V	
RX Squelch	Method of RX squelch implemented				Remarks	
Not implemented	N.A					

A0H Device register description

IIC Site	Byte size	Register name	Register description	Value(HEX)
0	1	Identifier	SFP	03
1	1	Extended Identifier	Use the IIC interface	04
2	1	Connector	Use the LC connector	07
3-10	8	Transceiver	1000 Base LX	00 00 00 02 00 00 01 01
11	1	Encoding	Use the 8B/10B coding scheme	01
12	1	BR, Nominal	1.25Gb/s nominal rate	0D
13	1	Rate Identifier	No rate selection	00
14	1	Length(9μm)-km	In single-mode fiber transmission 120km	78
15	1	Length (9μm)-100m	In single-mode fiber transmission 120km	FF
16	1	Length (50μm)-10m	The transmission distance in the multimode fiber	00
17	1	Length (62.5μm)-10m	The transmission distance in the multimode fiber	00
18	1	Length (Copper)	The transmission distance over the copper cable	00
19	1	Reserved	Undefined	00
20-35	16	Trade name	SONGXIN	ASCII Format
36	1	Transceiver	Undefined	00
37-39	3	Vendor OUI	Vendor IEEE company ID	00 00 00
40-55	16	Vendor PN	Vendor's product model	Vendor defined
56-59	4	Vendor Revision Number	Vendor's product version number	Vendor defined
60-61	2	Wavelength	According to the actual wavelength of the laser	According to the actual wavelength of the laser
62	1	Reserved	Undefined	00
63	1	CC_BASE	0-62 Check and of bytes	Vendor defined
64-65	2	Transceiver Options	1.Rx_LOS monitoring 2.Tx_FAULT monitoring 3.Tx_DIS monitoring	00 1A
66	1	BR, max	High bit rate margin	00

67	1	BR, min	Low bit rate margin	00
68-83	16	Vendor SN	Vendor serial number	Vendor defined
84-91	8	Date code	The date code	Vendor defined
92	1	Monitoring Type	DOM Information internal calibration	68
93	1	Enhanced Options	1. Emitting and receiving light alarm and warning monitoring 2. Tx_DIS Signal monitoring and control 3. Rx_LOS Signal monitoring 4. Tx_FAULT monitoring	F0
94	1	Compliance	As defined in SFF-8472 in version 12.0	08
95	1	CC_EXT	64-94 Check and bytes	Vendor defined
96-127	32	Vendor Specific	Vendor custom areas	Vendor defined
128-255	128	Vendor Specific	Vendor custom areas	Vendor defined

Digital Diagnostic Functions

SFP-GE-CWXX-ZX-C-GEN supports the 2-wire serial communication protocol as defined in SFP MSA. Digital diagnostic information is accessible over the 2-wire interface at the address 0xA2. Digital diagnostics for SFP-GE-CWXX-ZX-C-GEN are internally calibrated by default. The internal micro control unit accesses the device operating parameters in real time, such as transceiver temperature, laser bias current, transmitted optical power, received optical power and transceiver supply voltage. The module implements the alarm function of the SFP MSA, alerts the user when a particular operating parameter exceeds the factory-set normal range.

DDM Threshold Information

Parameter	Alarm Threshold		Warning Threshold	
	High Value	Low Value	High Value	Low Value
Temperature (°C)	75 (4B 00)	-5 (FB 00)	70 (46 00)	0(00 00)
Voltage (V)	3.63(8D CC)	2.97 (74 04)	3.46 (87 28)	3.13 (7A 44)
Bias Current (mA)	100 (C3 50)	2 (03 E8)	80 (9C 40)	4 (07 D0)
Tx Power (dBm)	5.79 (94 3B)	-0.97 (03 81)	5 (7B 86)	0 (27 10)
Rx Power (dBm)	-5.99 (09 D5)	-33.1 (00 05)	-9 (04 EA)	-30 (00 0A)

Parameter	Symbol	Accuracy	Units	Report Range		Unit	Remarks
Internal Calibration							
Temperature	Temp	±3	°C	-40	95	°C	
Voltage	V _{CC}	±0.1	V	2.7	3.9	V	
Bias Current	I _{bias}	±10	%	1	80	mA	
Tx Power	P _{TX}	±3	dB	-5	5	dBm	
Rx Power	P _{RX}	±3	dB	-35	-5	dBm	

Block-Diagram-of-Transceiver

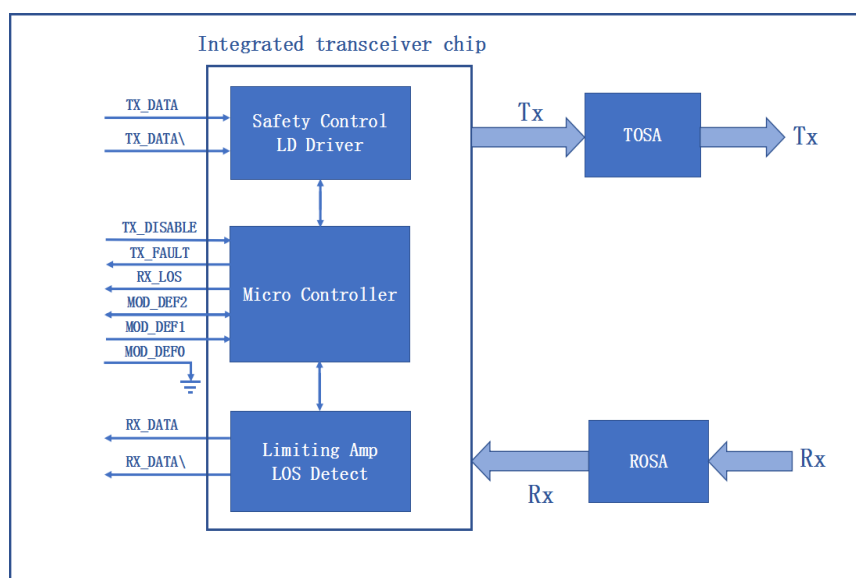

Functions Description

The transmitter is mainly composed of a laser driver part of the intelligent transceiver chip and a TOSA (light-emitting component). The TOSA includes a DFB laser and a backlight photodetection chip. When the module is working, the input signal is connected to the intelligent transceiver chip, at this time, the laser driver of the intelligent transceiver chip supplies the bias current and the modulation current to the laser. The intelligent transceiver chip simultaneously uses an automatic optical power control (APC) feedback loop to maintain a constant average optical power of the laser output. The purpose is to eliminate the change of the output optical signal due to temperature changes and aging of the light source device. When the transmitter enable pin (TX_Disable) is high (TTL logic "1"), the laser output is turned off. When TX_Disable is low (TTL logic "0"), the laser will turn on within 1ms. When the transmitter fault signal (TX_Fault) is reported as high, indicates a transmitter failure caused by the transmitter's bias current or transmitted optical power or laser tube temperature exceeding a preset alarm threshold. Low indicates normal operation.

The receiver is mainly composed of a limiting amplifier part of the intelligent transceiver chip and a ROSA (light-receiving component). The ROSA includes a PIN photodetector and a transimpedance amplifier

chip. When the ROSA detects the incident light signal, it will be converted into a photo-generated current by the PIN photodetector. The photo-generated current is converted into an electrical signal after passing through the transimpedance amplifier. The electrical signal is further amplified by the limiting amplifier, then outputs a fixed-amplitude electrical signal to the host. When the amplitude of the electrical signal received from the incident light conversion of the opposite optical transceiver module is lower than the set threshold, the module reports that the received signal is lost, the RX_LOS pin is high (logic "1"), which can be used to diagnose whether the physical signal is normal. The signal is operated in TTL level. The microprocessor inside the module monitors the module's operating voltage, temperature, transmitted optical power, received optical power, and laser bias current value in real time. The host acquires this information over a 2-wire serial bus.

The security level 2 password of this module is 0x12345678, method to enter safety level 2 operating status: Write the security level 2 password successively in the register 7B 7E of module A2H, namely 0x12、0x34、0x56、0x78; After entering safety level 2 working state, writes to registers other than A0H_LOW、A2H_T00、A2H_T01, the module may not work and need to be returned to the factory for repair.

Product weight

The module of weight: 17.0 Grams of each

Dust cap weight: 0.95 Grams of each

Dimensions

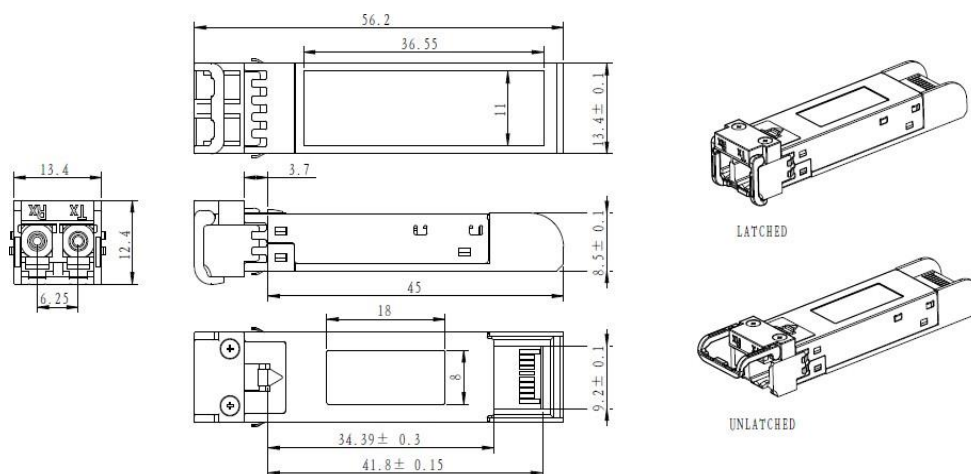

ALL DIMENSIONS ARE $\pm 0.2\text{mm}$ UNLESS OTHERWISE SPECIFIED
UNIT: mm

Electrical Pad Layout

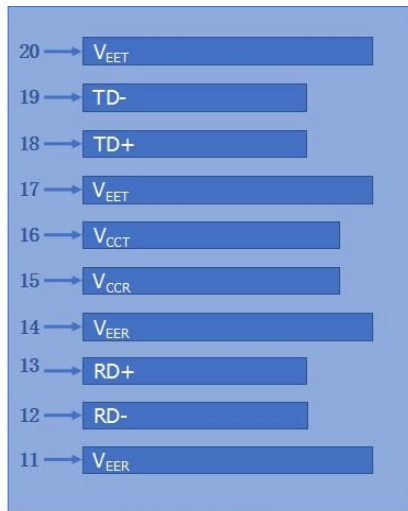

Top of Board

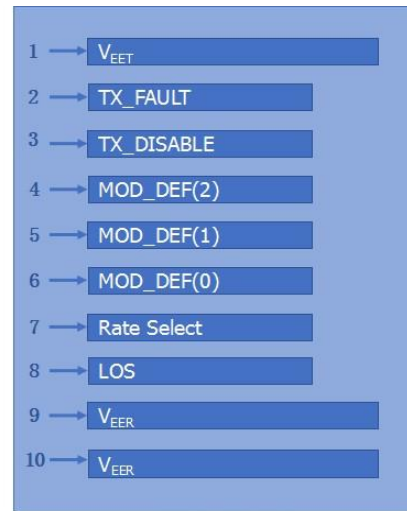

Bottom of Board

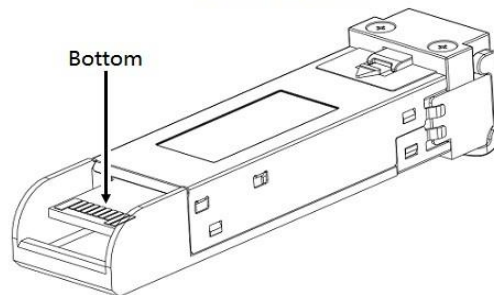
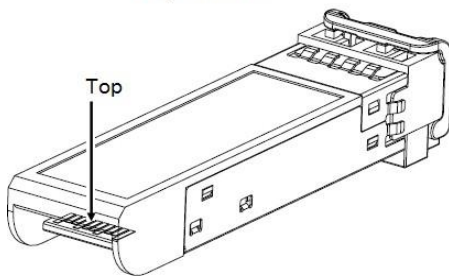

Pin Assignment

PIN #	Symbol	Description	Remarks
1	V _{EET}	Transmitter ground (common with receiver ground)	1
2	TX_FAULT	Transmitter Fault. Not supported	
3	TX_DISABLE	Transmitter Disable. Laser output disabled on high or open	2
4	MOD_DEF(2)	Module Definition 2. Data line for serial ID	3
5	MOD_DEF(1)	Module Definition 1. Clock line for serial ID	3
6	MOD_DEF(0)	Module Definition 0. Grounded within the module	3
7	Rate Select	No connection required	
8	LOS	Loss of Signal indication. Logic 0 indicates normal operation	4
9	V _{EER}	Receiver ground (common with transmitter ground)	1
10	V _{EER}	Receiver ground (common with transmitter ground)	1
11	V _{EER}	Receiver ground (common with transmitter ground)	1
12	RD-	Receiver Inverted DATA out. AC coupled	
13	RD+	Receiver Non-inverted DATA out. AC coupled	
14	V _{EER}	Receiver ground (common with transmitter ground)	1
15	V _{CCR}	Receiver power supply	
16	V _{CCT}	Transmitter power supply	
17	V _{EET}	Transmitter ground (common with receiver ground)	1
18	TD+	Transmitter Non-Inverted DATA in. AC coupled	
19	TD-	Transmitter Inverted DATA in. AC coupled	
20	V _{EET}	Transmitter ground (common with receiver ground)	1

Notes:

1. Circuit ground is isolated from chassis ground
2. Disabled: T_{DIS}>2V or open, Enabled: T_{DIS}<0.8V
3. Should Be pulled up with 4.7k - 10k ohm on host board to a voltage between 2V and 3.6V
4. LOS is open collector output

References

1. IEEE standard 802.3. IEEE Standard Department, 2002.
2. Small Form Factor Pluggable (SFP) Transceiver Multi-Source Agreement (MSA), INF-8074i.
3. Fiber Channel Draft Physical Interface Specification (FC-PI 10.0).
4. Digital Diagnostics Monitoring Interface for Optical Transceivers – SFF-8472.